

# HOW TO MAKE YOUR OWN POP UP FLOWER

Suitable for 7yrs and up

## YOU WILL NEED:

- A cardboard toilet tube
- 2 kebab sticks
- Scissors
- Sticky tape
- Glue
- Newspaper, brown paper or wrapping paper

1. Take your toilet roll and cut down it's length. and overlap these edges to make the diameter smaller, about 2.5cm. Tape in place.

fig 1

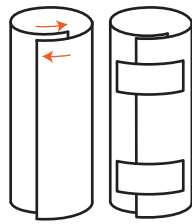

2. Cut a piece of paper 9.5cm x 42cm (fig 2).

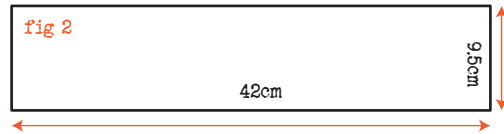

3. Fold it along the long edge into 1.5cm pleats (fig 3). I do this by making the first 1.5cm pleat and then using this as a guide.

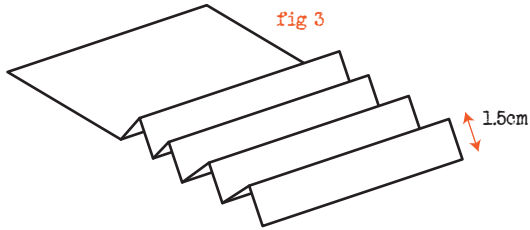

4. If you want to make petal shapes for your flower cut a curved shape to one end of your pleats. You might like to do this in two stages (fig 4).

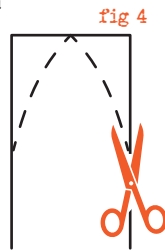

fig 5

5. At this point you may want to cut patterns into your flower, a bit like when you cut a snowflake. Make sure your pattern is only in the top two thirds of your pleated paper (fig 5).

6. Cut two strips of paper 15cm x 1cm and glue one to each side of the pleats, matching the bottom end of the pleats to one end of the strip (fig 6).

7. Tape the bottom 2.5cm of the pleats together. Then sandwich them between to kebab sticks and secure with more tape (fig 7).

fig 6

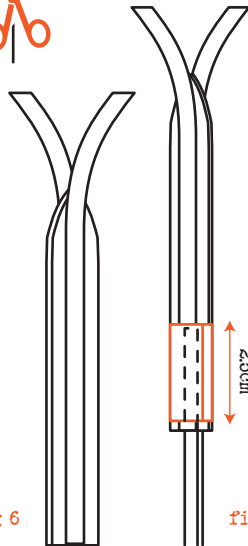
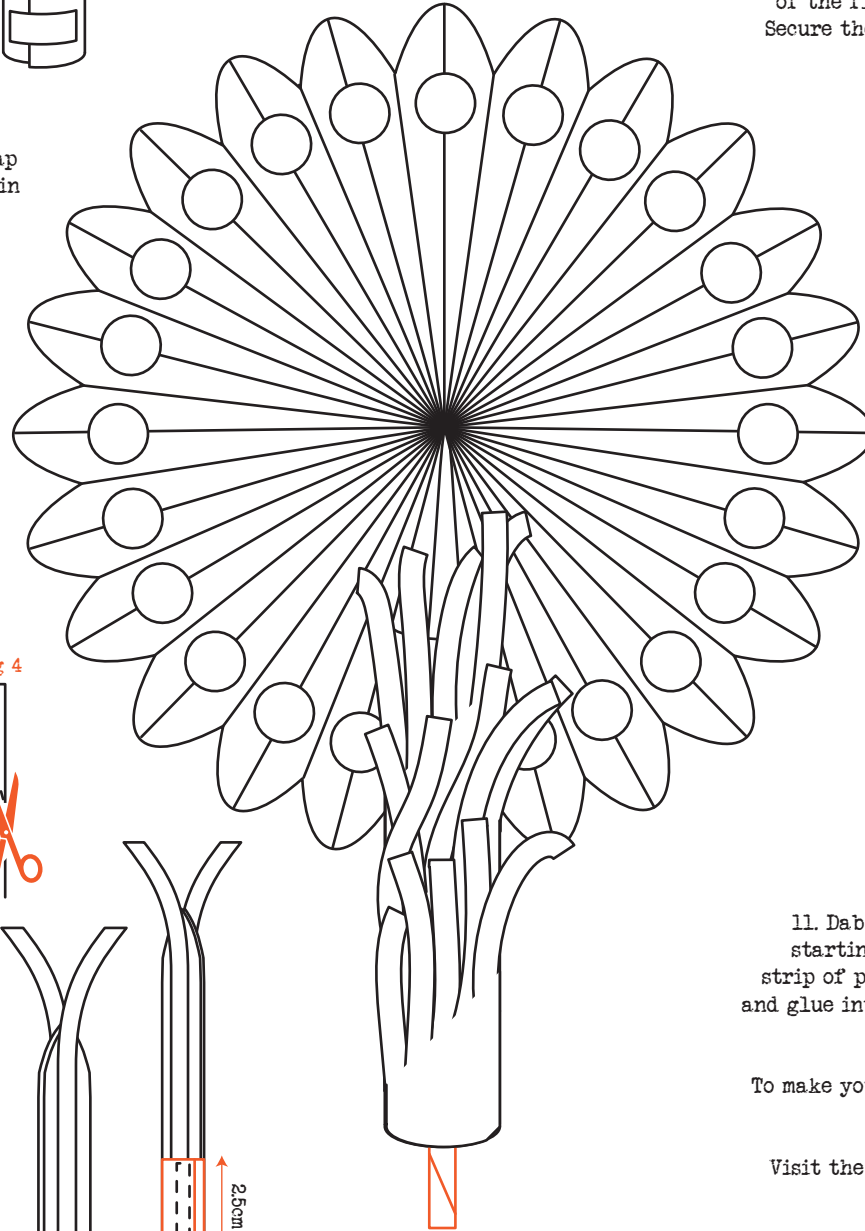

fig 7

# MAKE YOUR OWN POP UP FLOWER

EMMA CARLOW FOR DEPOT



8. Bind the two kebab sticks together using sticking tape wound around the stacks at an angle to form a handle (fig 8).

fig 8

9. Position your flower in the tube with the tip of the flower level with the top of the tube. Secure the bits of paper to the outside of the tube with glue (fig 9).

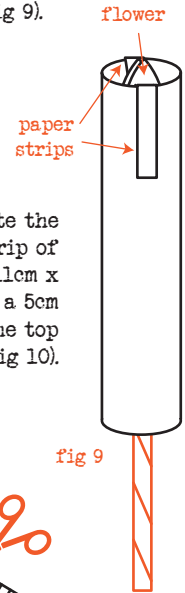

10. Now to decorate the tube. Cut a strip of paper roughly 11cm x 37cm and cut a 5cm fringe along the top long edge (fig 10).

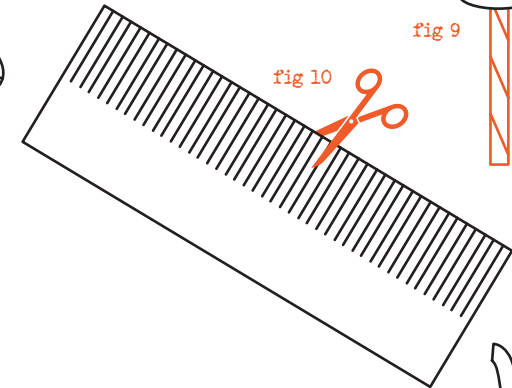

11. Dab a spot of glue at the top of the tube and, starting at the top of the tube, wind the fringed strip of paper at a 45 degree angle around the tube and glue into position at the bottom (fig 11). Trim off any excess paper at the bottom.

To make you flower bloom, gently push the handle up inside the tube and watch it open up.

Visit the 'Free Fun' page on [emmacarlow.com](http://emmacarlow.com) to see a video showing how to make this flower.

Enter our competition. Share pictures of your flowers and follow me and Depot on Instagram @emmacarlow @lewes\_depot for a chance to win cinema tickets and a shop local bag.

fig 11